



PROSECURE ALTECH LLP

ONE STOP DESTINATION FOR ALL NEEDS
ALUMINIUM | POWDER COATING | ANODIZING

INDEX

SILDING WINDOW 27 MM SERIES
SILDING WINDOW 18 MM SERIES
SILDING WINDOW 35 MM SERIES
CASEMENT WINDOW 40 MM SERIES
CASEMENT WINDOW 40 MM SLEEK SERIES
SILDING WINDOW 52 MM SERIES
CURTAIN WALL 57 MM SERIES
CURTAIN WALL 67MM SERIES
CASEMENT WINDOW 44 MM SERIES
DOOR & WINDOW 45 MM SERIES
DOOR SECTIONS
LOUVER SECTIONS

WEIGHT:

THE WEIGHTS KG/M GIVEN IN CATALOGUE ARE THE NOMINAL WEIGHTS. IN PRACTICE, TOLERANCE, ALLOY AND SUCH OTHER FACTORS WILL AFFECT THE FINAL WEIGHT AND A NORMAL VARIATION OF + OR - 10% SHOULD BE EXPECTED.



PROSECURE ALTECH LLP

ONE STOP DESTINATION FOR ALL NEEDS
ALUMINIUM | POWDER COATING | ANODIZING

PRO SECURE™

SILDING WINDOW 27 MM SERIES

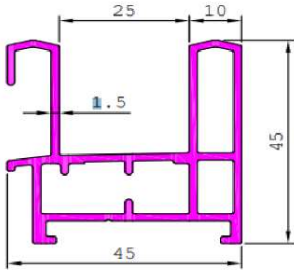

Section	PS-27501
Weight kg/m	1.004 Kg/m
Weight 15'	4.59 Kg

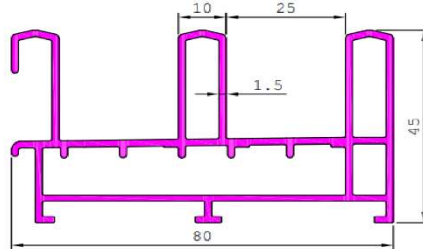

Section No	PS-27502
Weight kg/m	1.555 kg/m
Weight 15'	7.11 Kg

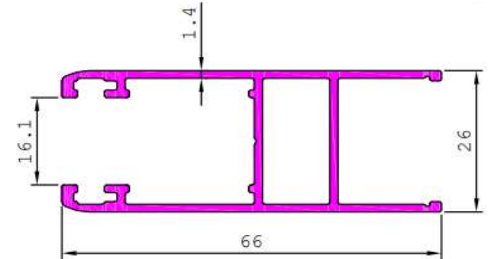

Section	PS-27503
Weight kg/m	0.774 kg/m
Weight 15'	3.54 Kg

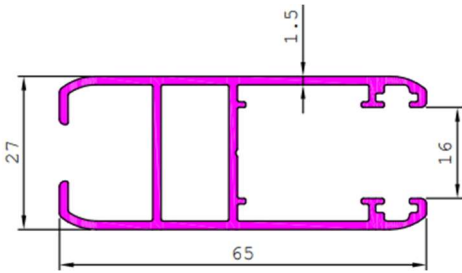

Section	PS-27504
Weight kg/m	0.851 Kg/m
Weight 15'	3.89 Kg

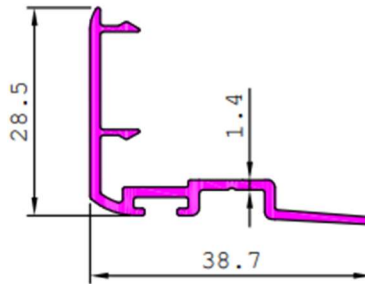

Section	PS-27505
Weight kg/m	0.303 Kg/m
Weight 15'	1.39 Kg

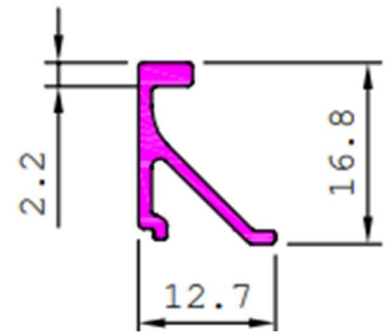

Section	PS-27506
Weight kg/m	0.133 Kg/m
Weight 15'	0.61 Kg

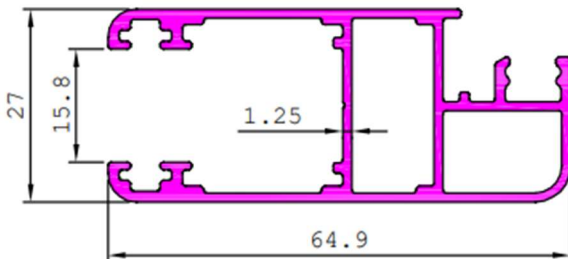

Section	PS-27507
Weight kg/m	0.875 Kg/m
Weight 15'	4.00 Kg



PROSECURE ALTECH LLP

ONE STOP DESTINATION FOR ALL NEEDS
ALUMINIUM | POWDER COATING | ANODIZING

PRO SECURE™

SILDING WINDOW 18 MM SERIES

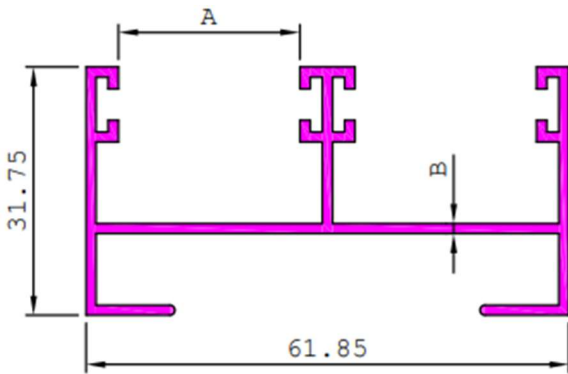

Section	PS-18501
Weight kg/m	0.659 Kg/m
Weight 15'	3.01 Kg

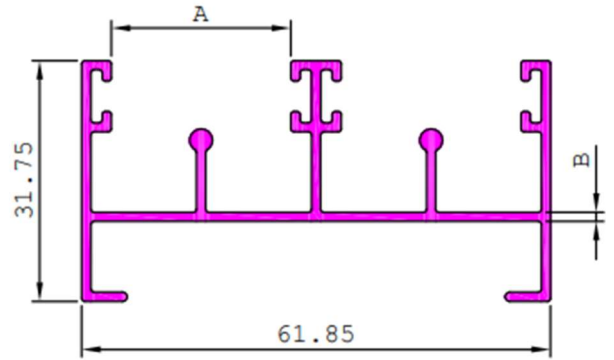

Section	PS-18502
Weight kg/m	0.695 Kg/m
Weight 15'	3.18 Kg

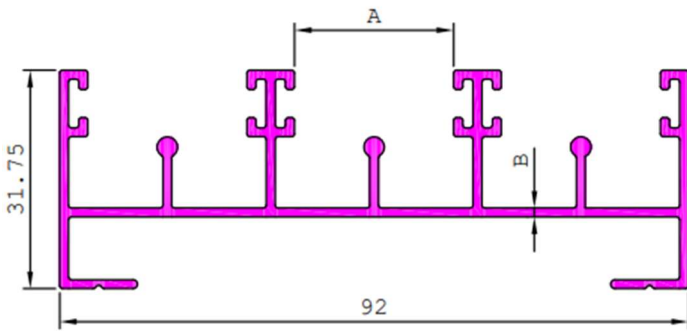

Section	PS-18503
Weight kg/m	1.065 Kg/m
Weight 15'	4.87 Kg

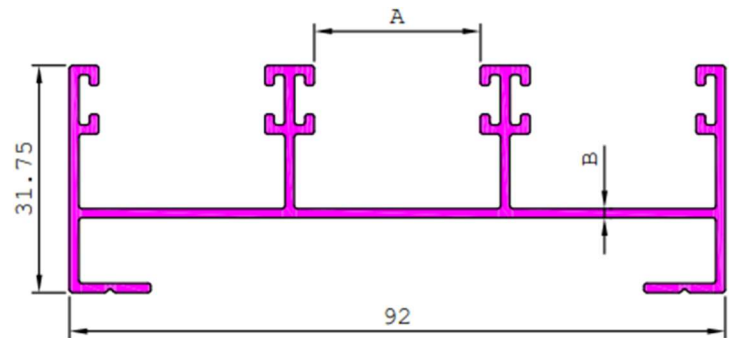

Section	PS-18504
Weight kg/m	0.929 Kg/m
Weight 15'	4.25 Kg

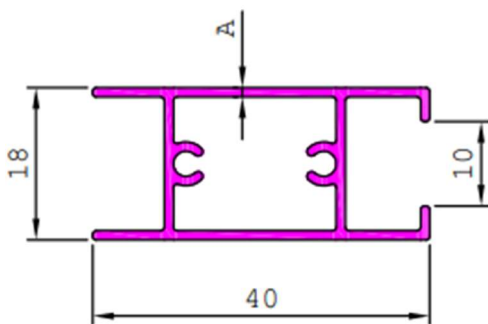

Name	PS-18505
Weight kg/m	0.547
Weight 15'	2.50 Kg

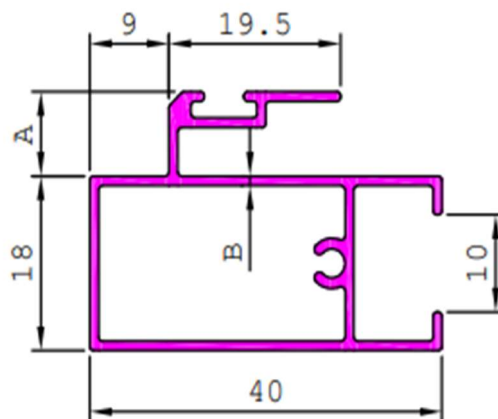

Section	PS-18506
Weight kg/m	0.607Kg/m
Weight 15'	2.78 Kg

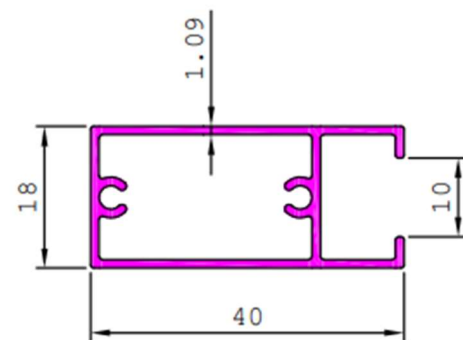

Section	PS-18507
Weight kg/m	0.547 Kg/m
Weight 15'	2.50 Kg



PROSECURE ALTECH LLP

ONE STOP DESTINATION FOR ALL NEEDS
ALUMINIUM | POWDER COATING | ANODIZING

PRO SECURE™

SILDING WINDOW 35 MM SERIES

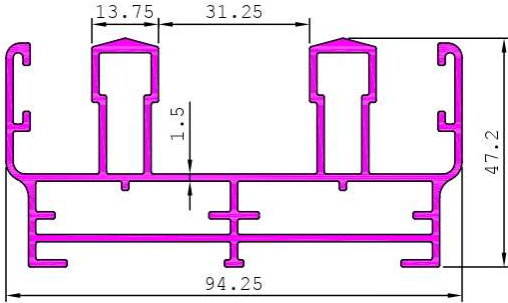

Section	PS-35501
Weight kg/m	1.972 Kg/m
Weight 15'	9.02 Kg

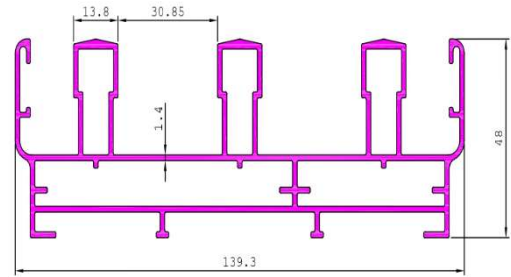

Section	PS-35502
Weight kg/m	2.480 Kg/m
Weight 15'	11.34 Kg

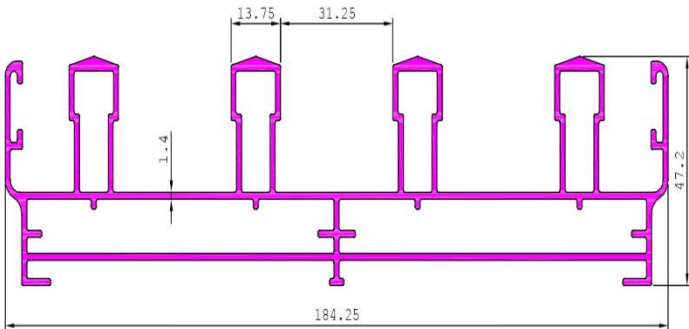

Section	PS-35503
Weight kg/m	3.109 Kg/m
Weight 15'	14.22 Kg

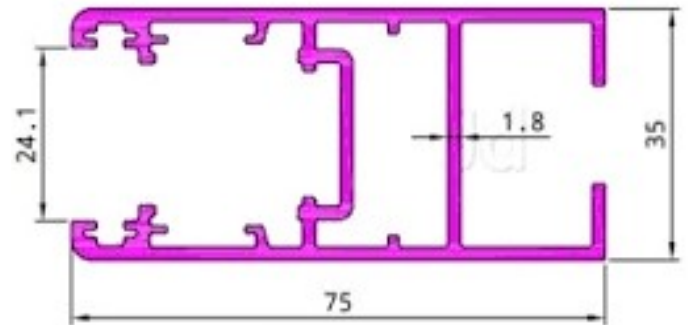

Section	PS-35504
Weight kg/m	1.385 Kg/m
Weight 15'	6.33 Kg

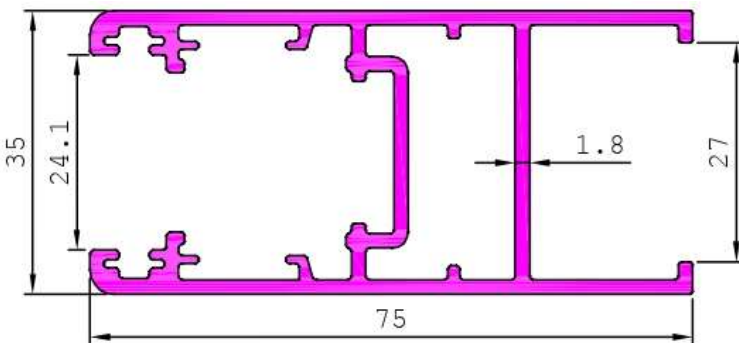

Section	PS-35505
Weight kg/m	1.319 Kg/m
Weight 15'	6.03 Kg

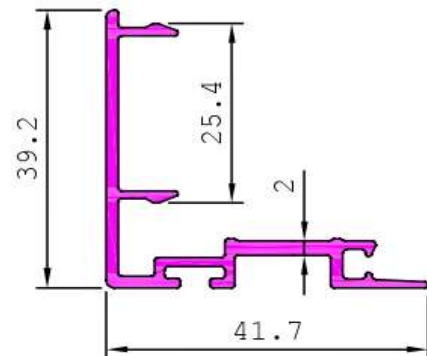

Section	PS-35506
Weight kg/m	0.468 Kg/m
Weight 15'	2.14 Kg



PROSECURE ALTECH LLP

ONE STOP DESTINATION FOR ALL NEEDS
ALUMINIUM | POWDER COATING | ANODIZING

PRO SECURE™

CASEMENT WINDOW 40 MM SERIES

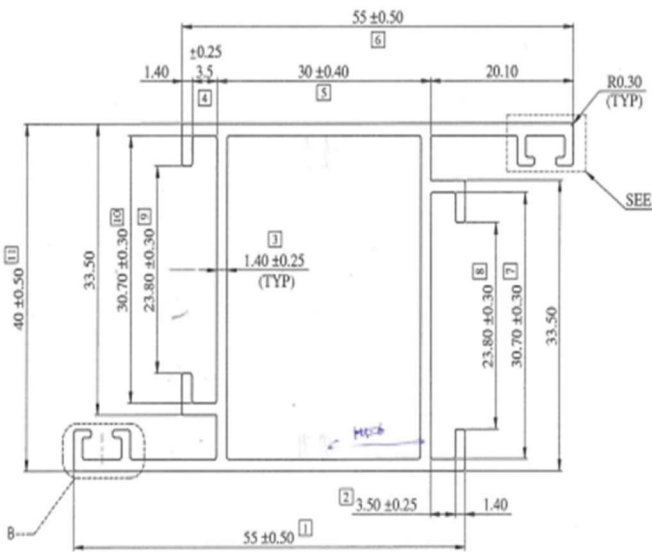

Section	PS-40501
Weight kg/m	0.842 Kg/m
Weight 15'	3.85 Kg

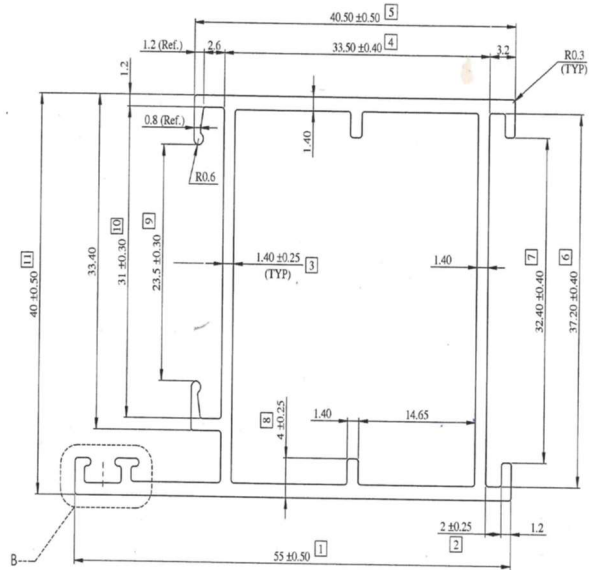

Section	PS-40502
Weight kg/m	0.726 Kg/m
Weight 15'	3.32 Kg

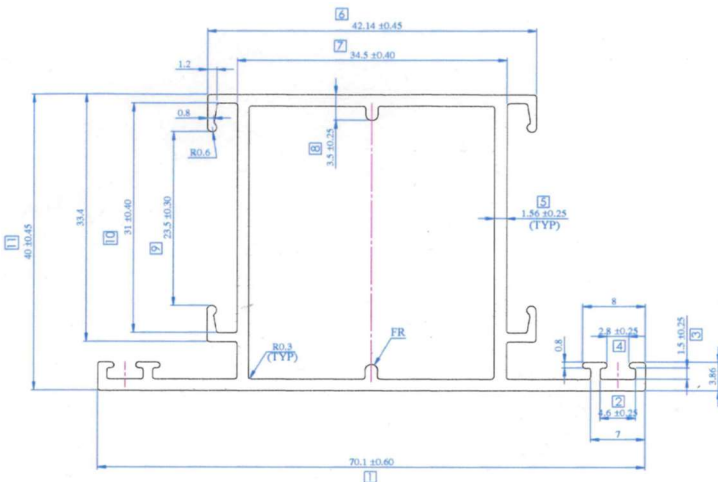

Section	PS-40503
Weight kg/m	0.898 Kg/m
Weight 15'	4.11 Kg

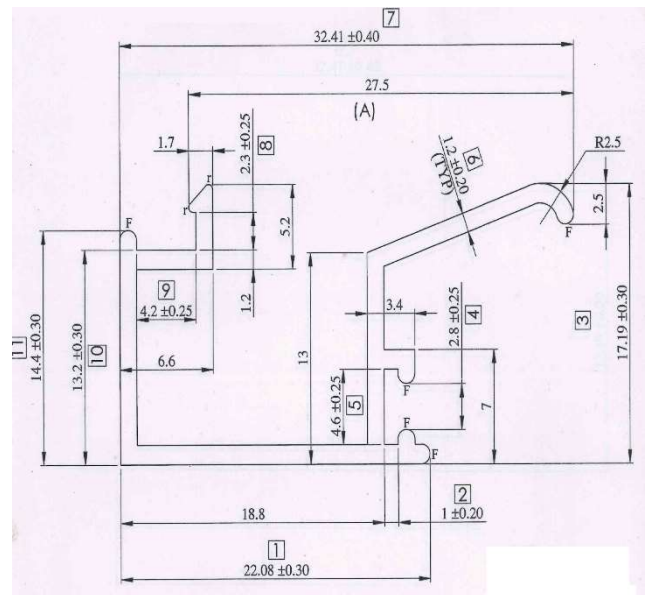

Section	PS-40504
Weight kg/m	0.243 Kg/m
Weight 15'	1.11 Kg



PROSECURE ALTECH LLP

ONE STOP DESTINATION FOR ALL NEEDS
ALUMINIUM | POWDER COATING | ANODIZING

PRO SECURE™

CASEMENT WINDOW 40 MM SLEEK SERIES

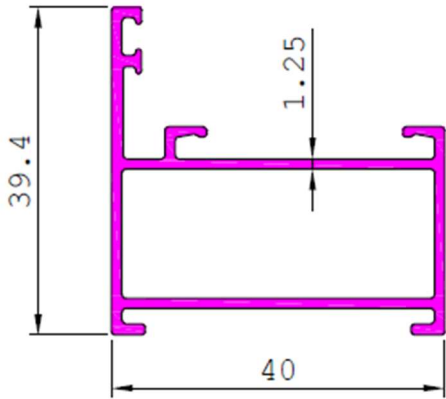

Section	S5180
Weight kg/m	0.550 Kg/m
Weight 15'	2.52 Kg

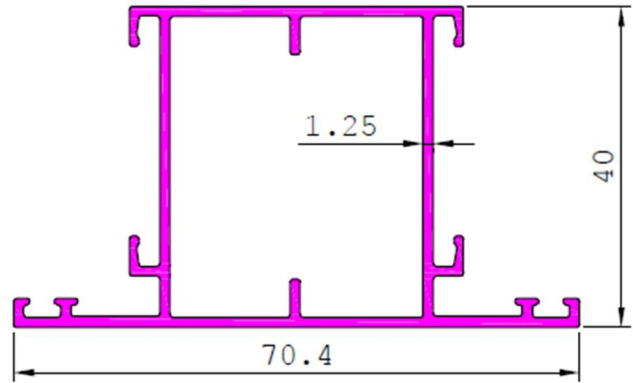

Section	S5181
Weight kg/m	0.782 Kg/m
Weight 15'	3.58 Kg

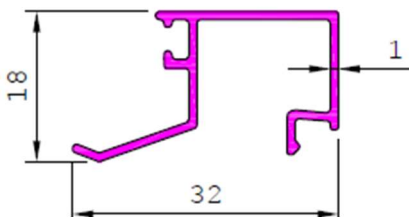

Section	S5179
Weight kg/m	0.210
Weight 15'	0.96 Kg

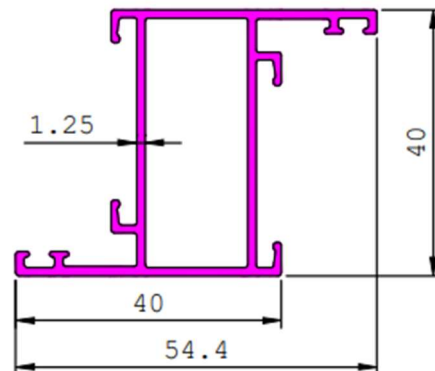

Section	G101573
Weight kg/m	0.641 Kg/m
Weight 15'	2.93 Kg

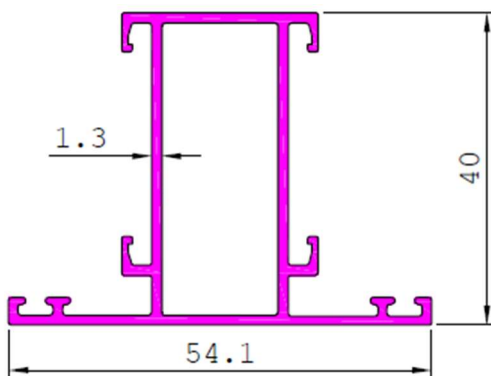

Section	21801
Weight kg/m	0.648 Kg/m
Weight 15'	2.96 Kg

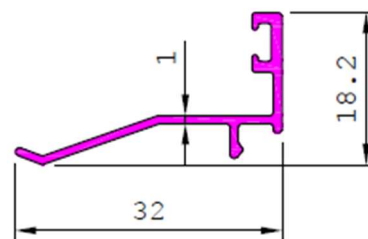

Section	41541
Weight kg/m	0.161 Kg/m
Weight 15'	0.74 Kg



PROSECURE ALTECH LLP

ONE STOP DESTINATION FOR ALL NEEDS
ALUMINIUM | POWDER COATING | ANODIZING

PRO SECURE™

CASEMENT WINDOW 52 MM SERIES

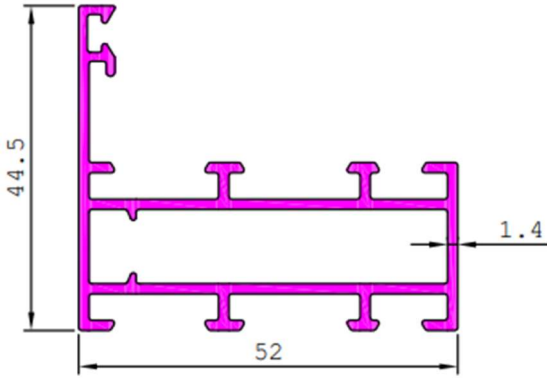

Section	PS-52501
Weight kg/m	0.842 Kg/m
Weight 15'	3.85 Kg

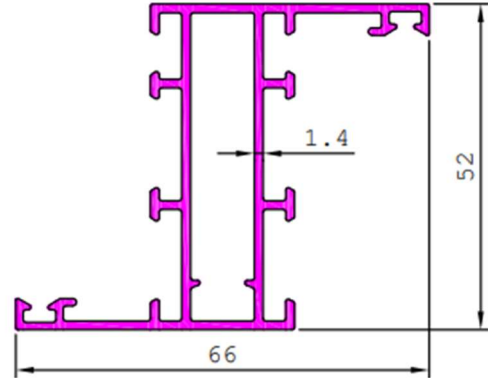

Section	PS-52502
Weight kg/m	0.956 Kg/m
Weight 15'	4.37 Kg

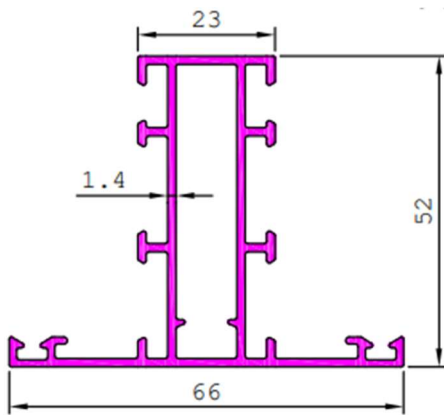

Section	PS-52503
Weight kg/m	0.956 Kg/m
Weight 15'	4.37 Kg

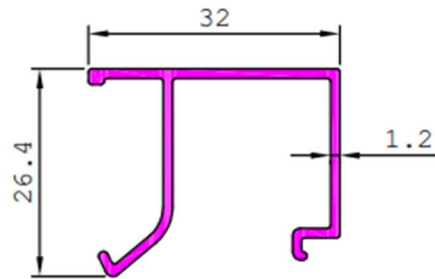

Section	PS-52504
Weight kg/m	0.297 Kg/m
Weight 15'	1.36 Kg



PROSECURE ALTECH LLP

ONE STOP DESTINATION FOR ALL NEEDS
ALUMINIUM | POWDER COATING | ANODIZING

PRO SECURE™

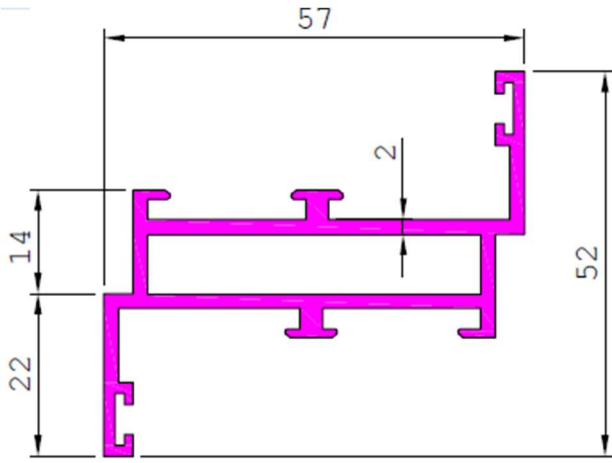

Section	PS-52505
Weight kg/m	1.065 Kg/m
Weight 15'	4.87 Kg

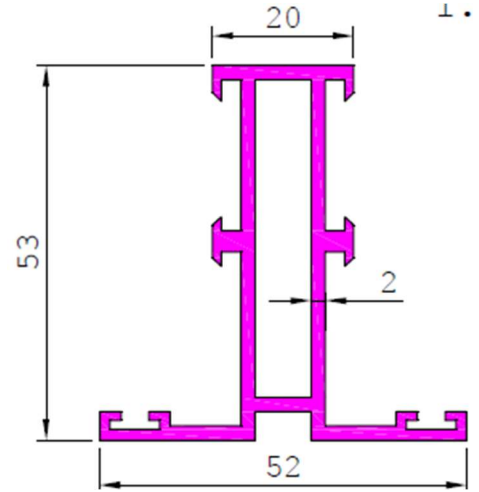

Section	PS-52506
Weight kg/m	1.065 Kg/m
Weight 15'	4.87 Kg

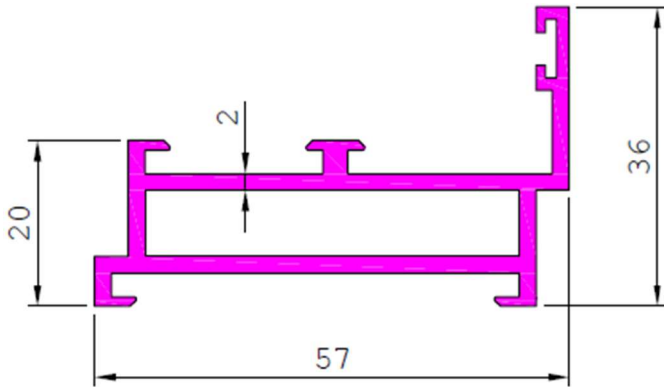

Section	PS-52507
Weight kg/m	0.918 Kg/m
Weight 15'	4.20 Kg

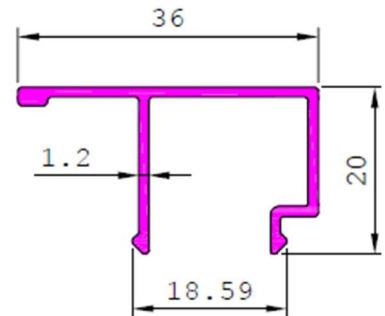

Section	PS-52508
Weight kg/m	0.266 Kg/m
Weight 15'	1.22 Kg



PROSECURE ALTECH LLP

ONE STOP DESTINATION FOR ALL NEEDS
ALUMINIUM | POWDER COATING | ANODIZING

PRO SECURE™

CURTAIN WALL 57MM SERIES

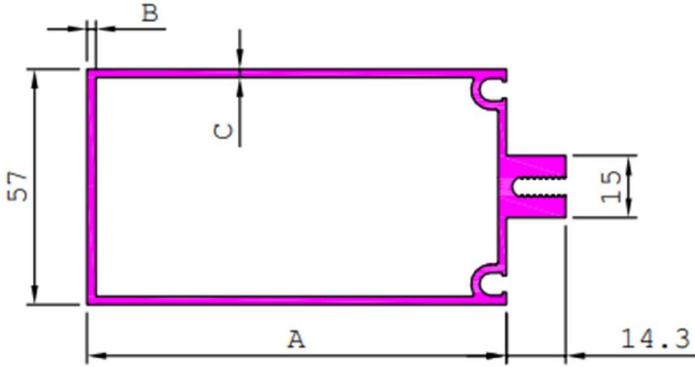

Section	PS-57501
Weight kg/m	2.187 Kg/m
Weight 15'	10.00 Kg
A	101.60
B	2.10
C	2.00

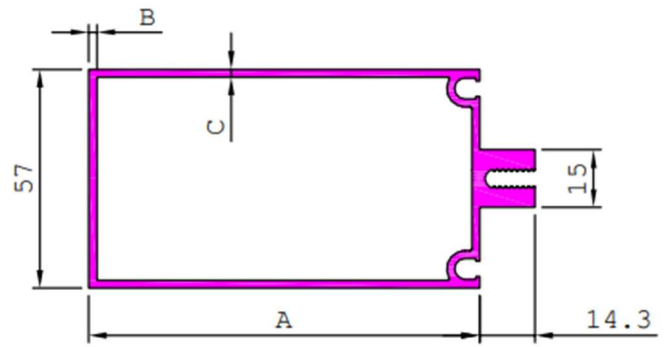

Section	PS-57502
Weight kg/m	1.777 Kg/m
Weight 15'	8.13 Kg
A	64.00
B	2.00
C	2.00

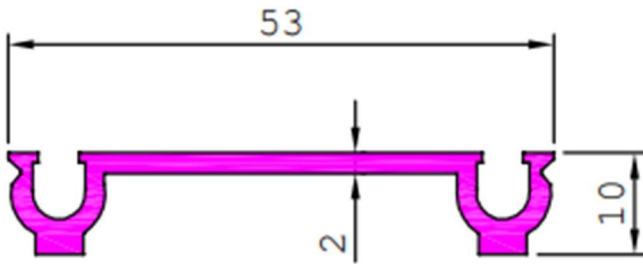

Section	PS-57503
Weight kg/m	0.434 Kg/m
Weight 15'	1.98 Kg

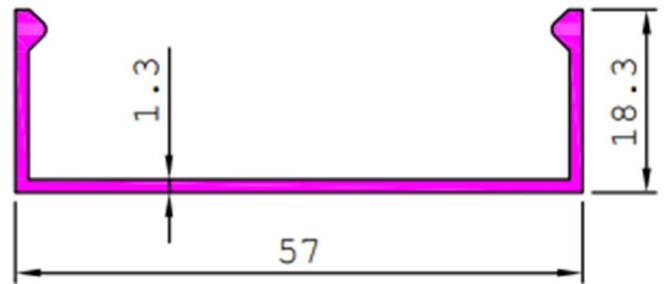

Section	PS-57504
Weight kg/m	0.343 Kg/m
Weight 15'	1.57 Kg



PROSECURE ALTECH LLP

ONE STOP DESTINATION FOR ALL NEEDS

ALUMINIUM | POWDER COATING | ANODIZING

PRO SECURE™

CURTAIN WALL 67MM SERIES

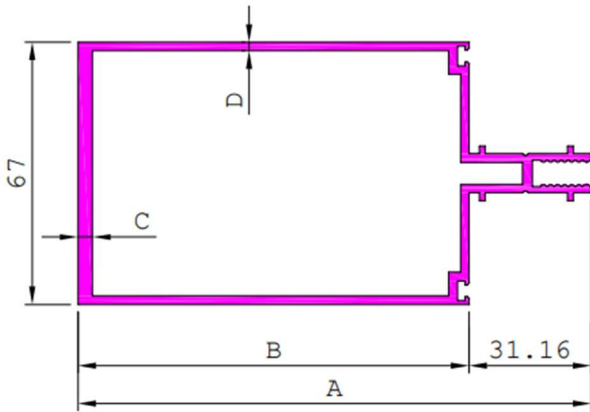

Section	PS-67501
Weight kg/m	1.615 Kg/m
Weight 15'	7.39 Kg
A	81.16
B	50
C	2
D	2

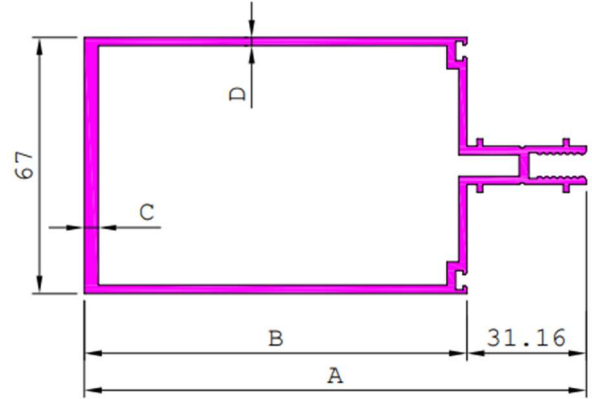

Section	PS-67502
Weight kg/m	2.947Kg/m
Weight 15'	13.48 Kg
A	131.16
B	100
C	3.70
D	2.20

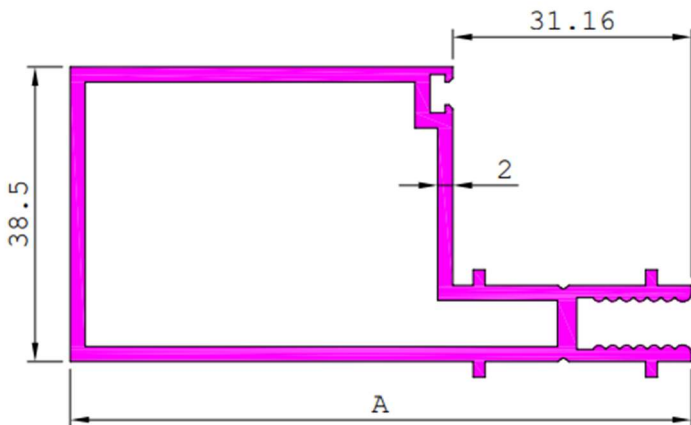

Section	PS-67503
Weight kg/m	1.294Kg/m
Weight 15'	5.92 Kg
A	81.16

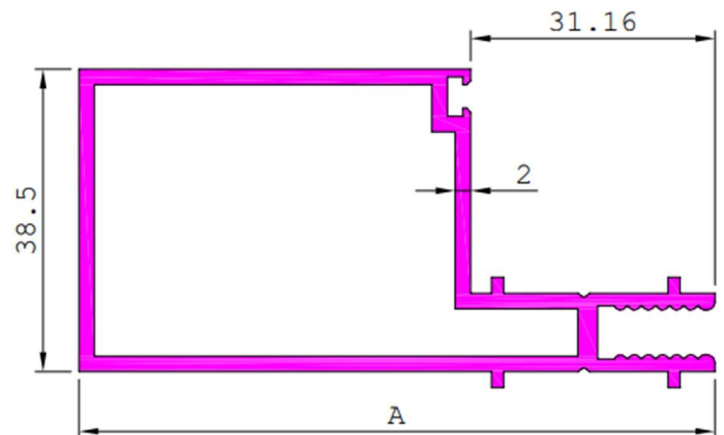

Section	PS-67504
Weight kg/m	1.881 Kg/m
Weight 15'	8.60 Kg
A	131.16



PROSECURE ALTECH LLP

ONE STOP DESTINATION FOR ALL NEEDS

ALUMINIUM | POWDER COATING | ANODIZING

PRO SECURE™

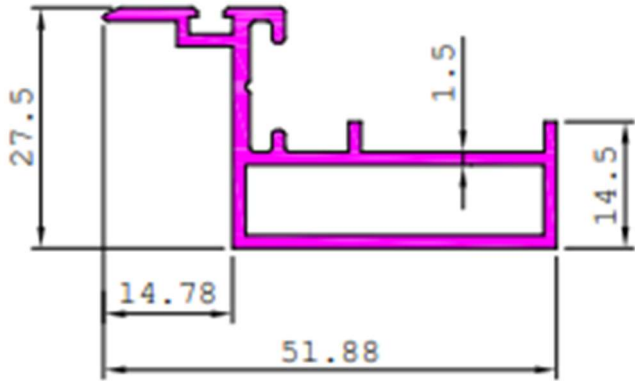

Section	PS-67505
Weight kg/m	0.586 Kg/m
Weight 15'	2.68 Kg

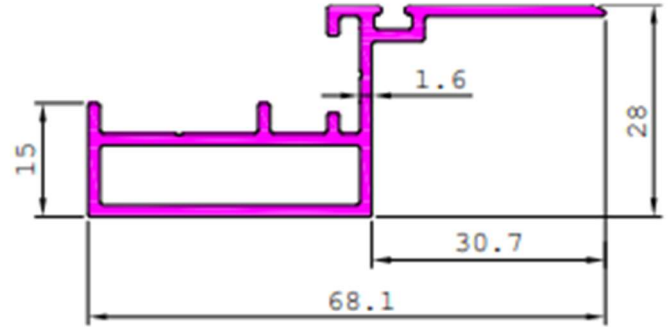

Section	PS-67506
Weight kg/m	0.693 Kg/m
Weight 15'	3.17 Kg

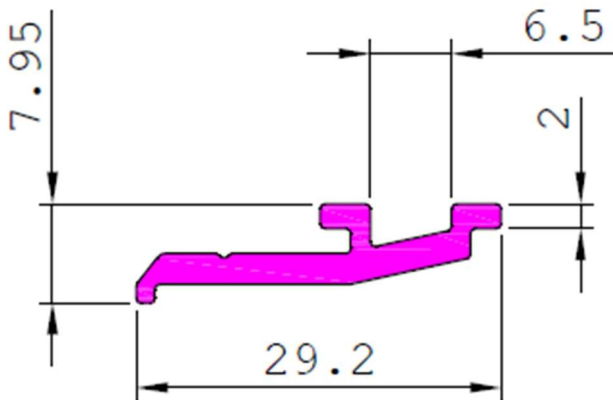

Section	PS-67507
Weight kg/m	0.230 Kg/m
Weight 15'	1.05 Kg



PROSECURE ALTECH LLP

ONE STOP DESTINATION FOR ALL NEEDS

ALUMINIUM | POWDER COATING | ANODIZING

PRO SECURE™

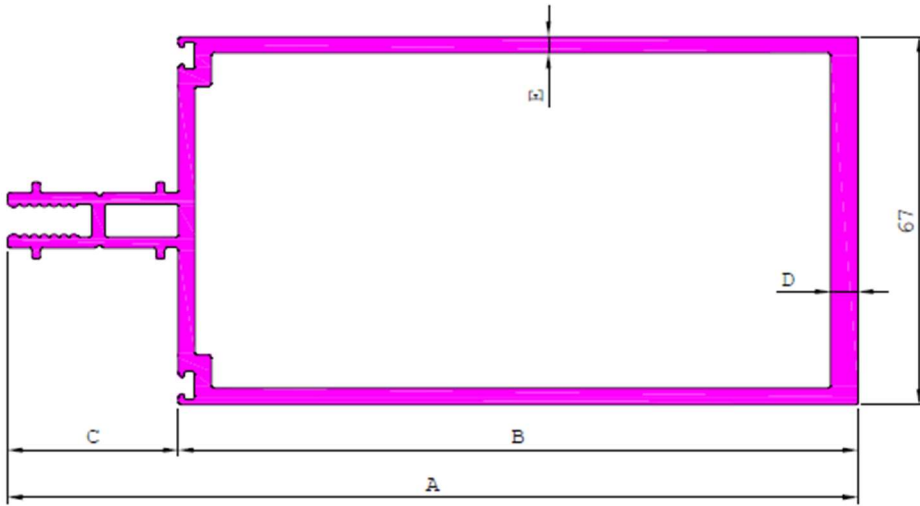

Section	PS-167508
Weight kg/m	3.929 Kg/m
Weight 15'	15.22 Kg

Section	PS-67509
Weight kg/m	0.693 Kg
Weight 15'	3.17 Kg

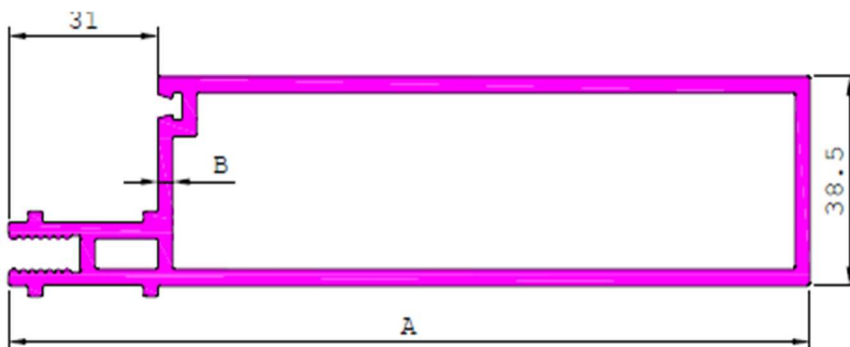
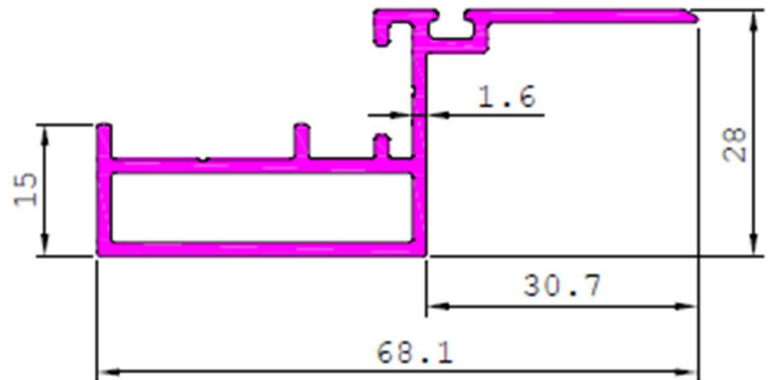

Section	PS-67510
Weight kg/m	3.361 Kg/m
Weight 15'	15.37 Kg



PROSECURE ALTECH LLP

ONE STOP DESTINATION FOR ALL NEEDS
ALUMINIUM | POWDER COATING | ANODIZING

PRO SECURE™

CASEMENT WINDOW 44 MM SERIES

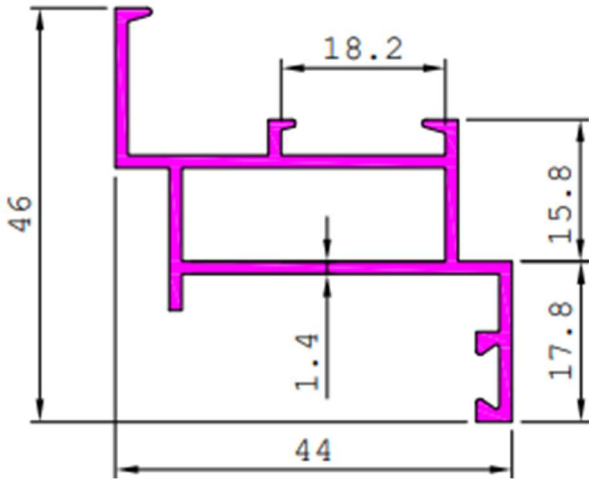

Section	PS-44501
Weight kg/m	0.575 Kg/m
Weight 15'	2.63 Kg

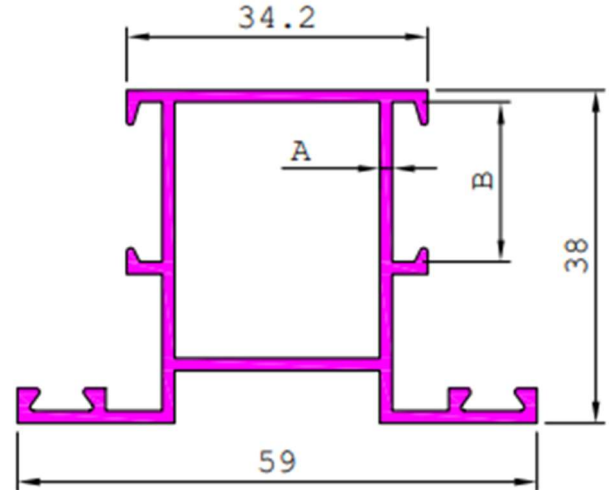

Section	PS-44502
Weight kg/m	0.729 Kg/m
Weight 15'	3.33 Kg

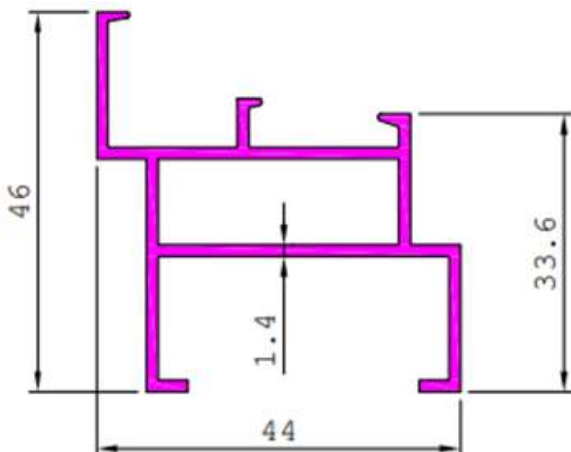

Section	PS-44503
Weight kg/m	0.622 Kg/m
Weight 15'	2.84 Kg

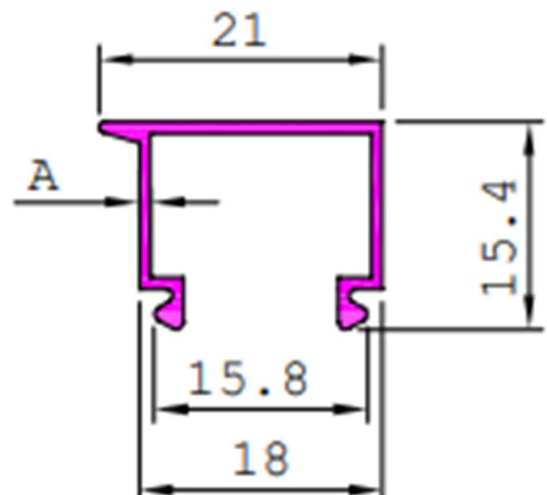

Section	PS-44504
Weight kg/m	0.108 Kg/m
Weight 15'	0.49 Kg



DOOR & WINDOW 45 MM SERIES

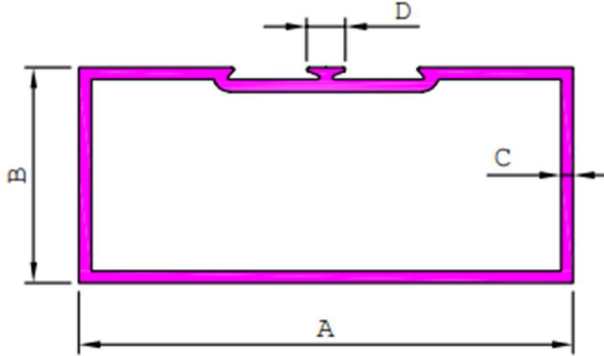

Section	PS-45501
Weight kg/m	0.818 Kg/m
Weight 15'	3.74 Kg
A	63.50
B	38.10
C	1.41
D	8

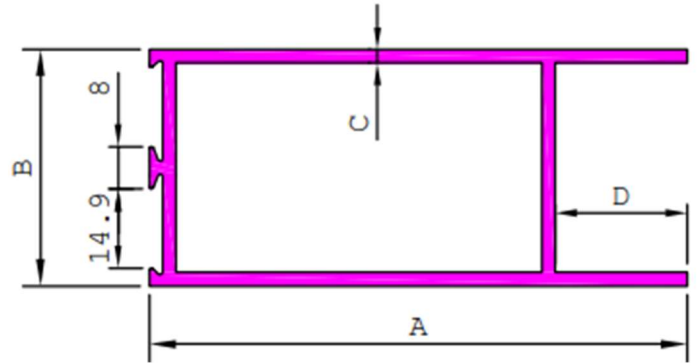

Section	PS-45502
Weight kg/m	1.302 Kg/m
Weight 15'	5.95 Kg
A	114.30
B	44.45
C	1.35
D	10.15

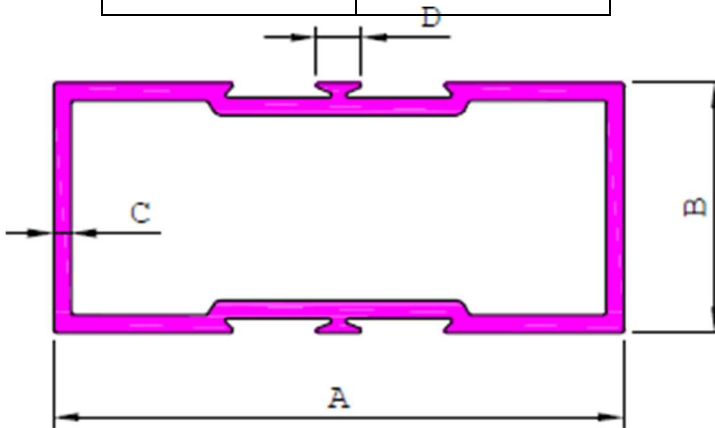

Section	PS-45503
Weight kg/m	0.942 Kg/m
Weight 15'	4.31 Kg
A	63.50
B	38.10
C	1.53
D	8.00

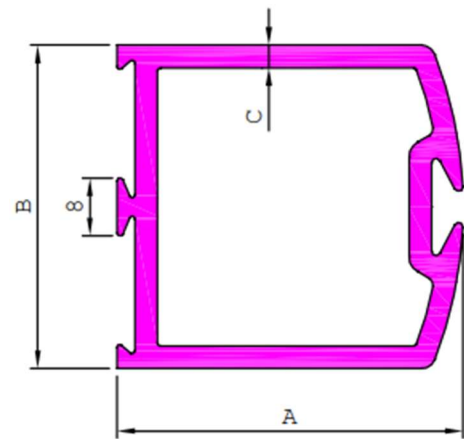

Section	PS-45504
Weight kg/m	1.417 Kg/m
Weight 15'	6.48 Kg
A	85
B	44.45
C	2

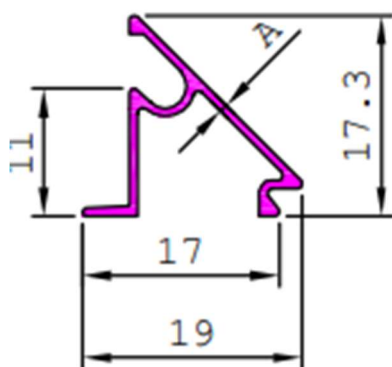

Section	PS-45505
Weight kg/m	0.071 Kg/m
Weight 15'	0.32 Kg
A	0.49



PROSECURE ALTECH LLP

ONE STOP DESTINATION FOR ALL NEEDS
ALUMINIUM | POWDER COATING | ANODIZING

PRO SECURE™

DOOR SECTIONS

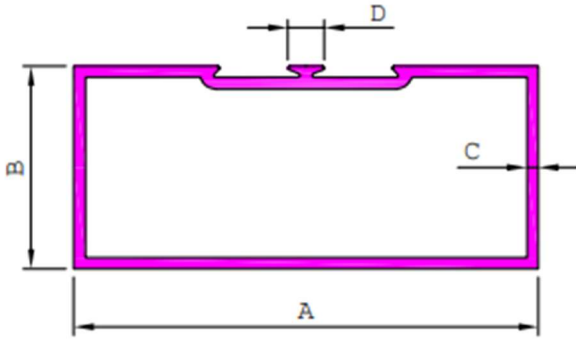

Section	PS-D501
Weight kg/m	2.343 Kg/m
Weight 15'	10.71 Kg
A	101.60
B	44.45
C	3
D	8

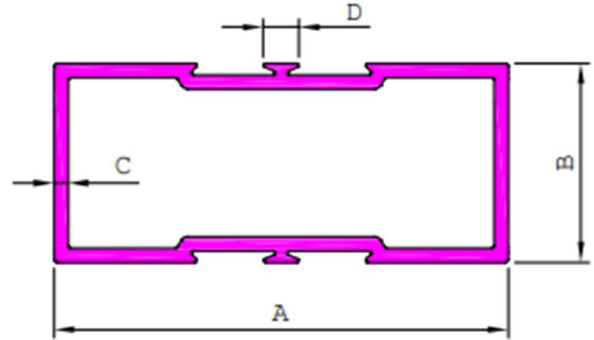

Section	PS-D502
Weight kg/m	2.415 Kg/m
Weight 15'	11.04 Kg
A	101.60
B	44.45
C	3
D	8

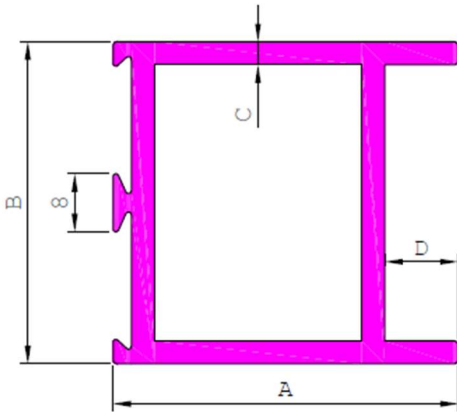

Section	PS-D503
Weight kg/m	1.843 Kg/m
Weight 15'	8.43 Kg
A	85.00
B	44.45
C	2.70
D	10

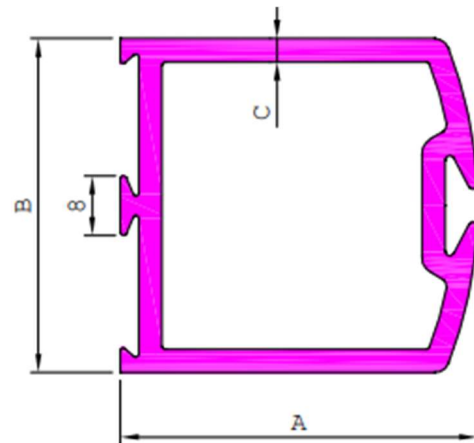

Section	PS-D504
Weight kg/m	2.050 Kg/m
Weight 15'	9.38 Kg
A	85.00
B	44.45
C	3.00



PROSECURE ALTECH LLP

ONE STOP DESTINATION FOR ALL NEEDS
ALUMINIUM | POWDER COATING | ANODIZING

PRO SECURE™

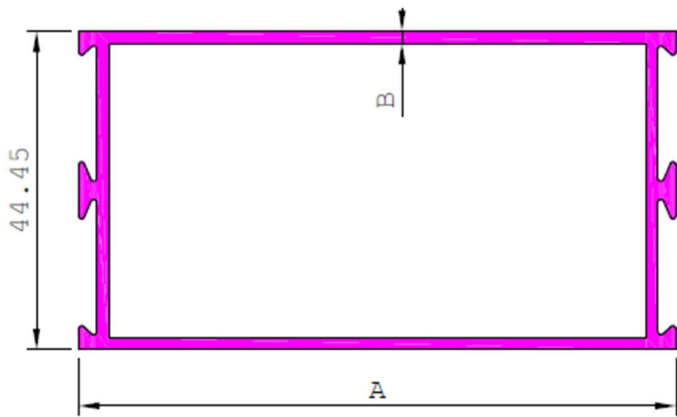

Section	PS-D505
Weight kg/m	2.145 Kg/m
Weight 15'	9.81 Kg
A	83.50
B	3.18

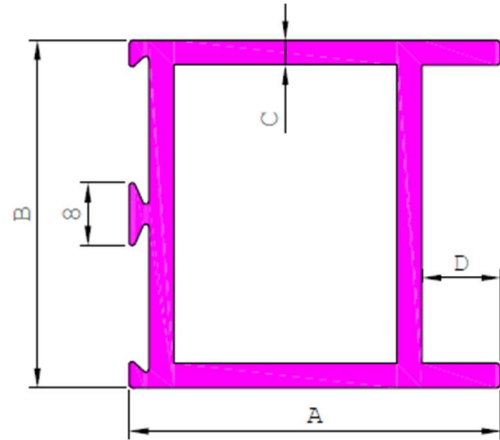

Section	PS-D506
Weight kg/m	3.181 Kg/m
Weight 15'	14.55 Kg
A	150.00
B	44.45
C	3.10
D	25.40

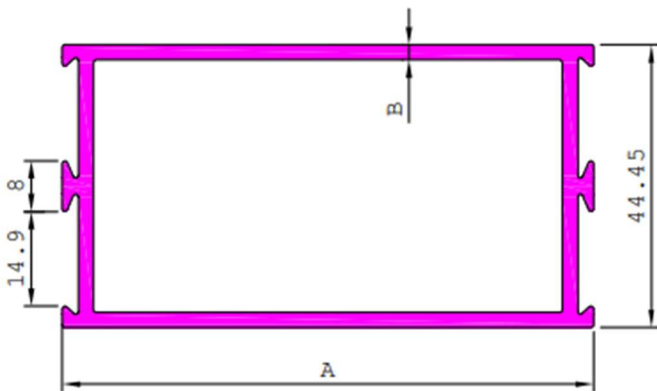

Section	PS-D507
Weight kg/m	2.779 Kg/m
Weight 15'	12.71 Kg
A	150.00
B	2.65

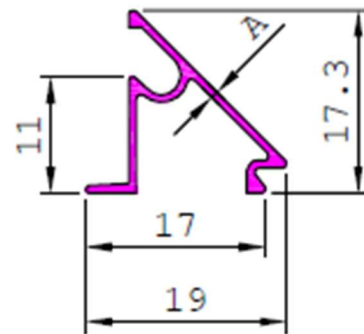

Section	PS-D508
Weight kg/m	0.124 Kg/m
Weight 15'	0.57 Kg
A	0.90



PROSECURE ALTECH LLP

ONE STOP DESTINATION FOR ALL NEEDS
ALUMINIUM | POWDER COATING | ANODIZING

PRO SECURE™

LOUVER SECTIONS

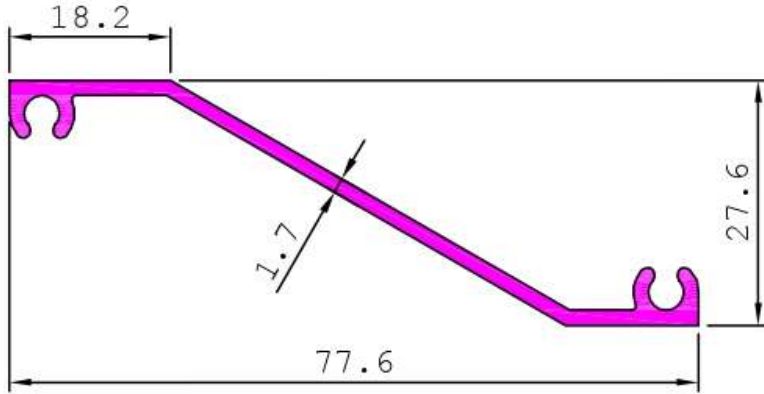

Section	PS-12501
Weight kg/m	0.483 Kg/m
Weight 15'	2.21 Kg

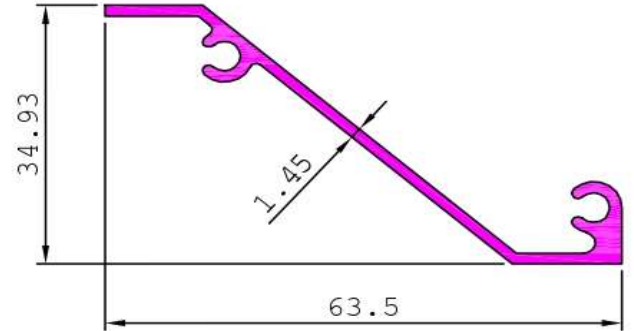

Section	PS-12502
Weight kg/m	0.429 Kg/m
Weight 15'	1.96 Kg

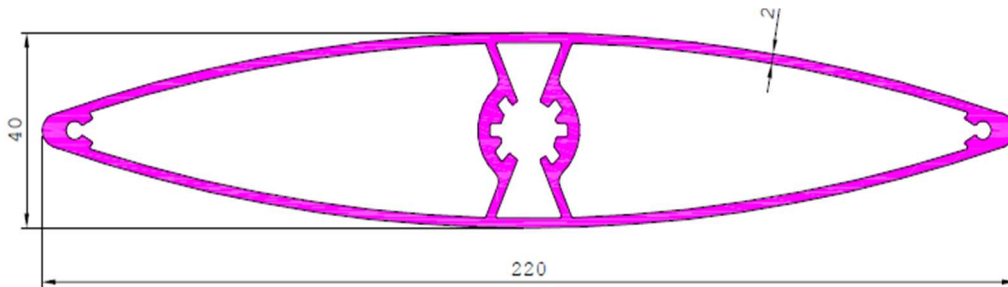

Section	PS-12503
Weight kg/m	3.228 Kg/m
Weight 15'	14.76 Kg

Section	PS-12504
Weight kg/m	1.086 Kg/m
Weight 15'	4.97 Kg

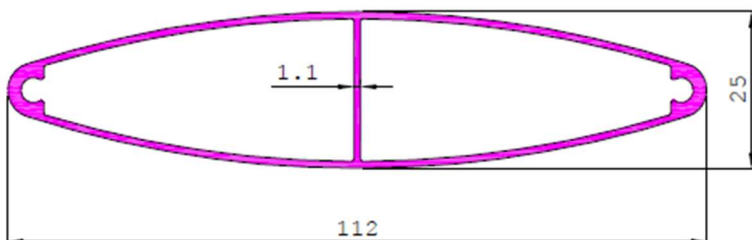
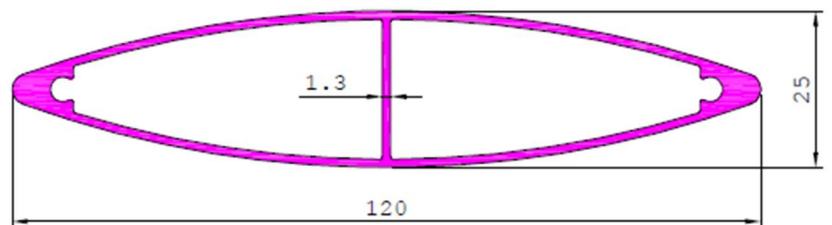

Section	PS-12505
Weight kg/m	0.843 Kg/m
Weight 15'	3.86 Kg



PROSECURE ALTECH LLP

ONE STOP DESTINATION FOR ALL NEEDS
ALUMINIUM | POWDER COATING | ANODIZING

PRO SECURE™

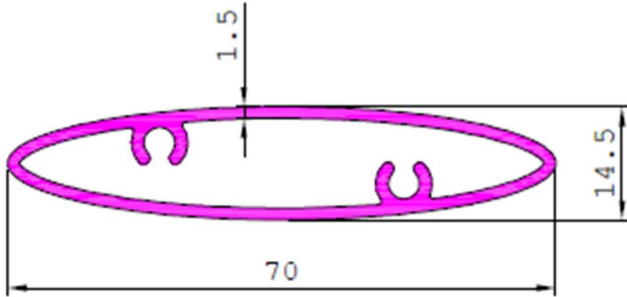

Section	PS-12506
Weight kg/m	0.678 Kg/m
Weight 15'	3.10 Kg



Section	PS-12507
Weight kg/m	0.706 Kg/m
Weight 15'	3.23 Kg

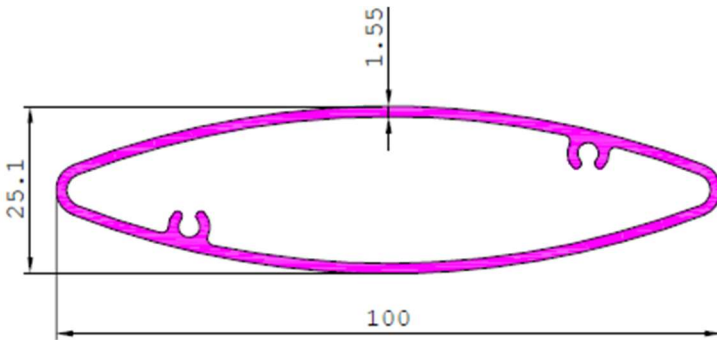

Section	PS-12508
Weight kg/m	0.954 Kg/m
Weight 15'	4.36 Kg

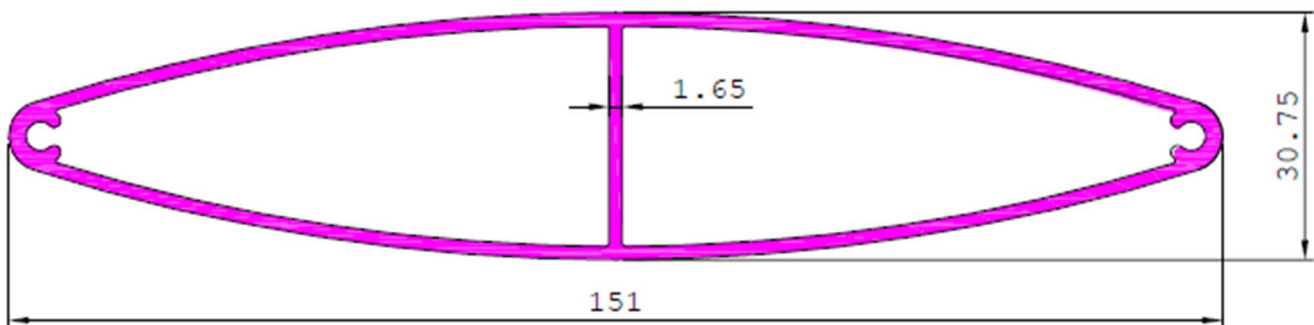

Section	PS-12509
Weight kg/m	1.573 Kg/m
Weight 15'	7.19 Kg



PROSECURE ALTECH LLP

ONE STOP DESTINATION FOR ALL NEEDS
ALUMINIUM | POWDER COATING | ANODIZING

PRO SECURE™

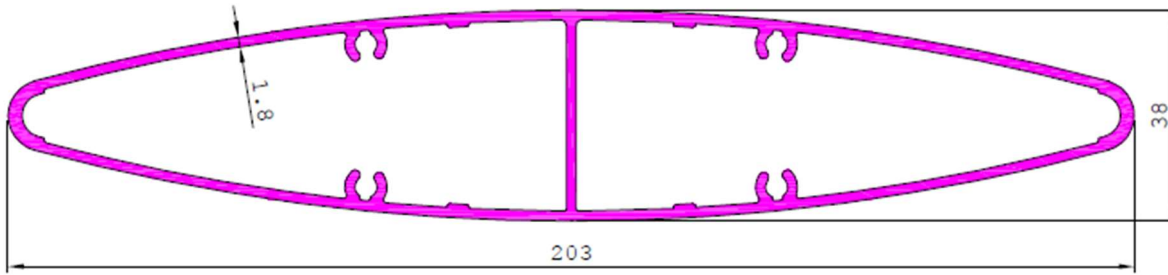

Section	PS-12510
Weight kg/m	2.511 Kg/m
Weight 15'	11.48 Kg

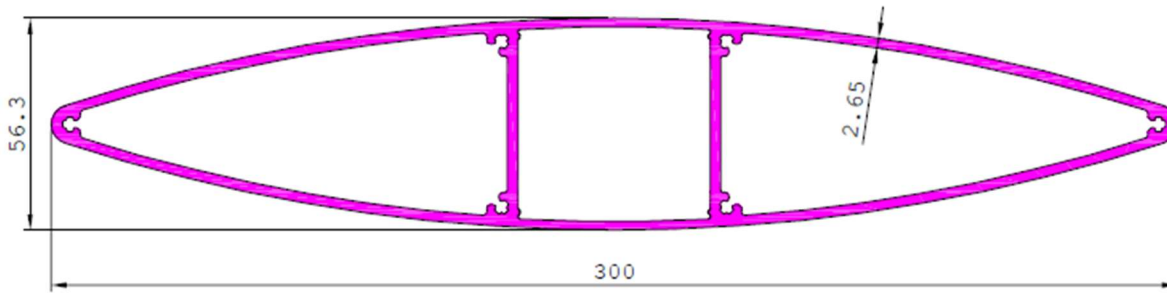

Section	PS-12511
Weight kg/m	5.293 Kg/m
Weight 15'	24.21 Kg

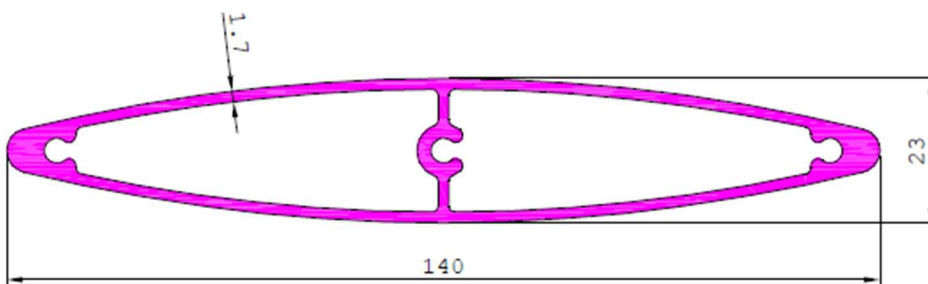

Section	PS-12512
Weight kg/m	1.624 Kg/m
Weight 15'	7.43 Kg

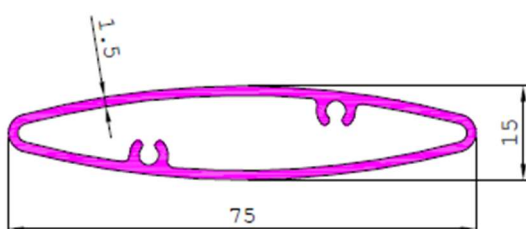

Section	PS-12513
Weight kg/m	0.693 Kg/m
Weight 15'	3.17 Kg